

COOLBOX

FC25



COOLBOX MANUAL



Ver:1.0

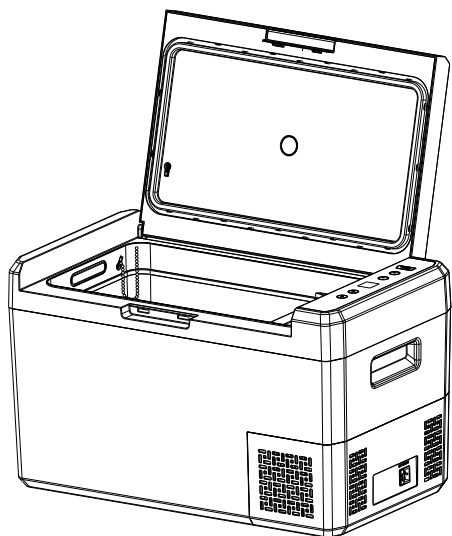

01

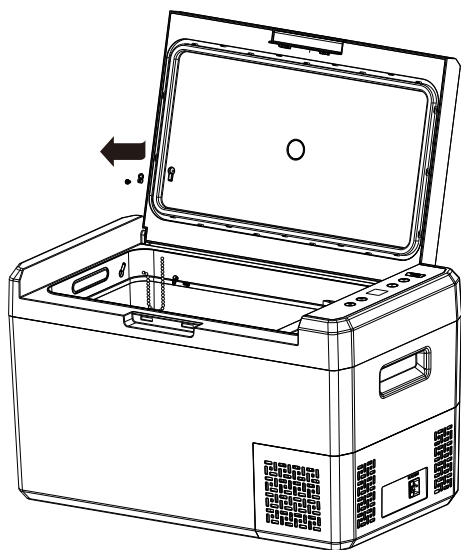

02

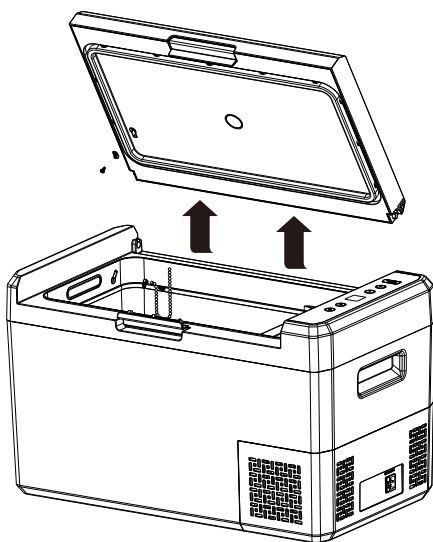

03

Please read this manual carefully before starting the device. Keep it in a safe place for future reference. If the device is passed on to another person, this manual must be handed over to the user along with it.

The manufacturer cannot be held liable for damage resulting from improper usage or incorrect operation.

Contents

1. Explanation of symbols	01
2. Safety instructions	01
3. Scope of delivery	08
4. Function description	08
4.1 Scope of functions	08
4.2 Operating and display elements	09
5. Operation	12
5.1 Before initial use	12
5.2 Energy saving tips	12
5.3 Connecting the cooler	12
5.4 Using the cooler	13
5.5 Setting the temperature	13
5.6 Battery Protection	14
5.7 Downloading Bluetooth App	14
5.8 Setting the Bluetooth signal and connecting to the APP	14
5.9 USB port for power supply	15
5.10 Defrosting the cooler	15
5.11 Replacing DC fuse	15
5.12 Replacing the fuse of the DC plug	16
5.13 Replacing the light PCB	16
6. Cleaning and maintenance	16
7. Troubleshooting	17
8. Guarantee	20
9. Disposal	20
10. Technical data	20

1 Explanation of symbols



DANGER!

Safety instruction: Failure to observe this instruction will cause fatal or serious injury.



CAUTION!

Safety instruction: Failure to observe this instruction can lead to injury.



NOTICE!

Failure to observe this instruction can cause material damage and impair the function of the product.



NOTE!

Supplementary information for operating the product.

2 Safety instructions

General requirements for all instructions CB, LVD:

- GWP: R134a: 1430
- This appliance is not intended for use by persons (including Children) with reduced physical, sensory or mental capabilities, or lack of experience and knowledge, unless they have been given supervision or instruction concerning use of the appliance by a person responsible for their safety.
- Children should be supervised to ensure that they do not play with the appliance.
- This appliance can be used by children aged from 8 years and above and

persons with reduced physical, sensory or mental capabilities or lack of experience and knowledge if they have been given supervision or instruction concerning use of the appliance in a safe way and understand the hazards involved. Children shall not play with the appliance. Cleaning and user maintenance shall not be made by children without supervision.

- Children aged from 3 to 8 years are allowed to load and unload refrigerating appliances.
- It must only be supplied at safety extra low voltage corresponding to the marking on the appliance.
- If the supply cord is damaged, it must be replaced by the manufacturer, its service agent or a similarly qualified person in order to avoid a hazard.
- Suitable for camping use and the appliance shall not be exposed to rain.

CAUTION

- Please keep the products away from the fire or similar glowing substance before you dispose the refrigerator.
- Disconnect the power supply before cleaning and maintenance.
- Do not store explosive substances such as aerosol cans with a flammable propellant in this appliance.
- This appliance is intended to be used in household and similar applications such as
 - staff kitchen areas in shops, offices and other working environments;
 - farm houses and by clients in hotels, motels and other residential type environments;
 - bed and breakfast type environments;
 - catering and similar non-retail applications.

WARNING!

When positioning the appliance, ensure the supply cord is not trapped or damaged.

WARNING!

Do not locate multiple portable socket-outlets or portable power supplies at the rear of the appliance.

To avoid contamination of food, please respect the following instructions:

- Opening the door for long periods can cause a significant increase of the temperature in the compartments of the appliance.
- Clean regularly surfaces that can come in contact with food and accessible drainage systems.
- Store raw meat and fish in suitable containers in the refrigerator, so that it is not in contact with or drip onto other food.
- If the refrigerating appliance is left empty for long periods, switch off, defrost, clean, dry, and leave the door open to prevent mould developing within the appliance.

Correct Disposal of this product



- This marking indicates that this product should not be disposed with other household wastes throughout the EU. To prevent possible harm to the environment or human health from uncontrolled waste disposal, recycle it responsibly to promote the sustainable reuse of material resources. To return your used device, please use the return and collection systems or contact the retailer where the product was purchased. They can take this product for environmental safe recycling.

For user manual, add following comment.

- This device complies with Part 15 of the FCC Rules. Operation is subject to the following two conditions: (1) this device may not cause harmful interference, and (2) this device must accept any interference received, including interference that may cause undesired operation.

FCC Caution:

- Changes or modifications not expressly approved by the part responsible for compliance could void the user's authority to operate the equipment.

FCC Statement:

- This equipment has been tested and found to comply with the limits for a Class B digital device, pursuant to part 15 of the FCC Rules. These limits are designed to provide reasonable protection against harmful interference in a residential installation. This equipment generates, uses and can radiate radio frequency energy and, if not installed and used in accordance with the instructions, may cause harmful interference to radio communications. However, there is no guarantee that interference will not occur in a particular installation. If this equipment does cause harmful interference to radio or television reception, which can be determined by turning the equipment off and on, the user is encouraged to try to correct the interference by one or more of the following measures:

- Reorient or relocate the receiving antenna.
- Increase the separation between the equipment and receiver.
- Connect the equipment into an outlet on a circuit different from that to which the receiver is connected.
- Consult the dealer or an experienced radio/TV technician for help."

RSS-Gen & RSS-247 statement:

- This device complies with Industry Canada licence-exempt RSS standard(s).
- Operation is subject to the following two conditions: (1) this device may not cause interference, and (2) this device must accept any interference, including interference that may cause undesired operation of the device.

- Le présent appareil est conforme aux CNR d'Industrie Canada applicables aux appareils radio exempts de licence. L'exploitation est autorisée aux deux conditions suivantes : (1) l'appareil ne doit pas produire de brouillage, et (2) l'utilisateur de l'appareil doit accepter tout brouillage radioélectrique subi, même si le brouillage est susceptible d'en compromettre le fonctionnement.

RSS-102 Statement:

- This equipment complies with Industry Canada radiation exposure limits set forth for an uncontrolled environment.
- Cet équipement est conforme à l'exposition aux rayonnements Industry Canada limites établies pour un environnement non contrôlé.



WARNING!

- Do not operate the cooling device if it is visibly damaged.
- If this cooling device's power cable is damaged, it must be replaced by the manufacturer, customer service or a similarly qualified person in order to prevent safety hazards.
- If the power cord of the refrigerator is damaged, it must be replaced to prevent safety hazards
- This cooling device may only be repaired by qualified personnel. Improper repairs can lead to considerable hazards.
- This cooling device can be used by children aged 8 years or over, as well as by persons with diminished physical, sensory or mental capacities or a lack of experience and/or knowledge, providing they are supervised or have been taught how to use the cooling device safely and are aware of the resulting risks.
- Cleaning and user maintenance must not be carried out by children without supervision.
- Children must be supervised to ensure that they do not play with the cooling device.

- Always keep and use the cooling device out of the reach of children under the age of 8 years.
- Do not store any explosive substances such as spray cans with a flammable propellant in the cooling device.



CAUTION!

- Before starting the refrigerator, make sure the power cord and plug are dry.
- Disconnect the cooling device from the power supply
 - before each cleaning and maintenance
 - after every use
- Food may only be stored in its original packaging or in suitable containers.



NOTICE!

- Check that the voltage specification on the type plate corresponds to that of the energy supply.
- Only connect the cooling device as follows:
 - With the DC connection cable to a DC power supply in the vehicle
 - Or with the AC connection cable to an AC power supply
- Never pull the plug out of the socket by the cable.
- If the refrigerator is connected to a DC outlet: Before connecting the fast charging device, disconnect the refrigerator and other power-consuming devices from the battery.

- If the cooling device is connected to a DC outlet: Disconnect the cooling device or switch it off when you turn off the engine. Otherwise you may discharge the battery
- The cooling device is not suitable for transporting caustic materials or materials containing solvents.
- The insulation of the cooling device contains flammable cyclopentane and requires special disposal procedures. Deliver the cooling device at the end of its life-cycle to an appropriate recycling center.
- Do not use electrical devices inside the cooling device unless they are recommended by the manufacturer for the purpose..
- Do not place the cooling device near naked flames or other heat sources (heaters, direct sunlight, gas ovens etc.)
- Ensure at all times that there is a minimum of 50 mm ventilation on all four sides of the cooling device.
- Keep the ventilation area free of any objects that could restrict the air flow to the cooling components.
- Do not place the cooling device in closed compartments or areas with none or minimal air flow.
- Ensure that the ventilation openings are not covered.
- Do not fill the inner container with ice or fluids.
- Never immerse the cooling device in water.
- Protect the cooling device and the cable against heat and moisture.

3 Scope of Delivery

No.	Quantity	Description
1	1	Cooler
2	1	Connection cable for DC connection
3	1	Connection cable for AC adapter
4	1	Operating manual

4 Function Description



This is a portable cooler . A fast-acting and efficient cooling system provides maintenance-free cooling performance with a thick insulation, powerful compressor and control module, and the cooler can withstand a heel (inclination) of 30° within a short period of time.

(Note: During working, if the inclination exceeds 15°, the compressor noise will increase accordingly.)

4.1 Scope of functions

- Power supply with AC adapter for connecting to the AC mains
- Three-level battery monitor to protect the vehicle battery
- Display with temperature gauge in °C and °F
- Temperature setting: With two buttons in steps of 1 °C (2 °F)
- Bluetooth App Control
- USB port for power supply, such as mobile phones.

4.2 Operating and display elements

No.	Description	Description
1		Switches the cooler on or off when the button is pressed for one or three seconds
2	Display	<p>Press button to switch the cooler on H/M/L: Battery voltage protection gear °C/°F: Temperature unit symbol</p> <p>❁ : Compressor is on ✎ : Bluetooth is on MAX : Maximum cooling mode ECO: Energy-saving cooling mode</p>
3		Press the "+" button to increase the temperature gauge or function selection. Press the "-" button to decrease the temperature gauge or function selection.
4		Press "⚙️" to select the function or save the setting memory

Display panel:

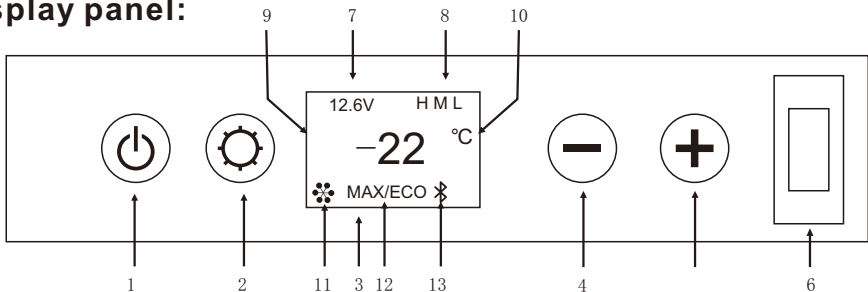

1. On/Off button
2. Setting button
3. LCD screen display
4. Down "-" button
5. Up "+" button
6. USB output port DC5V2A
7. voltage detection
8. ABS battery voltage protection gear setting
9. Temperature gauge display
10. °C/°F Celsius or Fahrenheit display
11. Compressor operation instructions
12. MAX/ECO function mode switching
13. Bluetooth function display

Button settings:

- A. **ON/OFF** switch button, short press 1s, then release the button, the device is **ON**; long press 3s, then release the button, the device is **OFF**.
ON: The LCD display lights up and the device starts cooling.
OFF: The LCD display lights out and the device stops working.
- B. Setting button, short press for 1s, then release the button to select and set the temperature; long press for 3s, then release the button to select and determine the battery voltage range (H/M/L range) , Temperature unit (°C/°F), MAX/ECO mode switching.
- 1) Temperature setting: Short press the Setting button for 1s, then release the button, the temperature figure starts to flash, press "-" and "+" to set the parameters; and then short press the Setting button for 1s or stop pressing the button for more than 10s to complete the setting.

- 2) When the refrigerator starts, the Bluetooth is away on, and you can use the mobile app to connect to the Bluetooth.
 - 3) Power input voltage range H/M/L setting: long press the Setting button for 3s, then release the button, the H/M/L letters begin to flash, and then short press the Setting button for 1s to switch between H/M/L Voltage gear.
 - 4) Celsius or Fahrenheit display switching: Press and hold the Setting button for 3s, then release the button, the °C/°F start to flash, and then short press "-" to switch the °C/°F temperature unit.
 - 5) Cooling mode switching: Long press the Setting button for 3s, then release the button, MAX/ECO will start flashing, and then short press "+" to switch the MAX/ECO cooling mode.
- C. +/UP button, set parameter +1 or function selection switching.
- D. -/Down button, set parameter -1 or function selection switching.

5 Operation

5.1 Before initial use



NOTE

Before starting your new cooler for the first time, you should clean it inside and outside with a damp cloth for hygienic reasons (please also refer to the chapter “Cleaning and maintenance”).

5.2 Energy saving tips

- Choose a well ventilated location which is protected from direct sunlight.
- Allow warm food to cool down first before placing it in the cooling device to keep cool.
- Do not open the cooling device more often than necessary.
- Do not leave the cooling device open for longer than necessary.
- Defrost the cooler once a layer of ice forms.
- Avoid unnecessarily low temperatures.

5.3 Connecting the cooler



NOTICE! Danger of damage!

Disconnect the cooler and other consumer units from the battery before you connect the battery to a quick charging device.

Overvoltage can damage the electronics of the device.

Connecting to AC mains (e.g. in the home or office)



DANGER! Danger of electrocution!

- Never handle plugs and switches with wet hands or if you are standing on a wet surface.
 - If you are operating your cooler on board a boat with an AC mains connection, you must install a residual current circuit breaker between the AC mains and the cooler.
- Seek advice from a trained technician.

5.4 Using the cooler



NOTICE! Danger of overheating!

Ensure at all times that there is sufficient ventilation so that the heat that generated during operation can dissipate. Ensure that the ventilation slots are not covered. Make sure that the device is sufficiently far away from walls and other objects so that the air can circulate.



NOTE

When operating with the battery, the display switches off automatically if the battery voltage is low.

5.5 Setting the temperature



NOTE!

The temperature of each compartment can be set to $-22\text{ }^{\circ}\text{C}$. The manufacturer however recommends a cooling temperature of $-15\text{ }^{\circ}\text{C}$ to $-18\text{ }^{\circ}\text{C}$ for normal usage and optimum energy consumption.



NOTE!

Be sure to set the temperature as you expect for the item that needs to be refrigerated to avoid too low a temperature on the itemTo damage.

5.6 Using the battery monitor

The device is equipped with a multi-level battery monitor that protects your vehicle battery against excessive discharging when the device is connected to the on-board DC supply.

If the cooler is operated when the vehicle ignition is switched off, the cooler switches off automatically as soon as the supply voltage falls below a set level. The cooler will switch back on once the battery has been recharged to the restart voltage level.



NOTICE! Danger of damage!

When the battery connected to the product is low in power, the product will stop working due to the battery protection function. In order to avoid frequent start-up and shutdown of the product, please charge the battery in time.

Avoid starting repeatedly or operating current consumers without longer charging phases. Ensure that the battery is recharged.



NOTE

When the cooler is supplied by the starter battery, select the battery monitor mode “HIGH”. If the cooler is connected to a supply battery, the battery monitor mode “LOW” will suffice.

5.7 Downloading Bluetooth APP

The cooler can be controlled via Bluetooth using an APP that you can install on a compatible device, to monitor and control products within a certain distance. (at 4.2 Button Setting B 2)

5.8 Setting the Bluetooth and connecting to the Car Refrigerator APP



NOTE

The pairing must be done in the Car Refrigerator APP, not in the device settings. Bluetooth connection does not require a password.

5.9 USB port for power supply

The USB port allows you to charge small devices like mobile phones and mp3-players.



NOTE

Ensure that any small device connected to the USB port is compatible with 5 V/2000mA operation.

5.10 Defrosting the cooler

Humidity can form frost in the interior of the cooling device or on the evaporators.



WARNING!

This reduces the cooling capacity. Defrost the device in good time to avoid this.

To defrost the cooler, proceed as follows:

- Take out the contents of the cooling device.
- If necessary, place them in another cooling device to keep them cool.
- Switch off the device.
- Leave the lids open.
- Wipe off the defrosted water.

5.11 Replace DC fuse

Update the replacement process:

- Locate the DC "FUSE" cover and pry open the fuse holder;
- Pull out the faulty blade fuse;
- Insert a new fuse with the same type and parameters;
- Restore the "FUSE" cover.

5.12 Replacing the fuse of the DC plug

- Replace the faulty fuse with a new fuse of the same model and rating.

5.13 Defrosting the cooler



NOTICE! Danger of damage!

The light PCB can only be replaced by the manufacturer, authorized repair center or similar qualified technician to avoid danger.

6 Cleaning and maintenance



NOTICE! Risk of damage

- Never clean the cooler under running water or in dish water.
- Do not use abrasive cleaning agents or hard objects during cleaning as these can damage the cooler.

Occasionally clean the device interior and exterior with a damp cloth.

During the use of the refrigerator, condensation water will appear at the door seal. This is a normal phenomenon and can be cleaned with a damp cloth.

Make sure that the air inlet and outlet vents on the device are free of any dust and dirt, so that heat can be released and the device is not damaged.

7 Troubleshooting

Fault	Possible cause	Suggested remedy
This device does not function (DC Mode, the ignition is on).	No voltage was detected in the DC power outlet	In most vehicles the ignition must be turned on before power will be supplied to the DC power outlet.
	The DC socket is dirty, resulting in poor electrical contact.	If the plug of this product becomes very hot on the DC socket of the vehicle, try to clean the DC socket or check if the plug is assembled correctly.
	The fuse of the DC power cord plug has blown.	Replace the device fuse
	The car's fuse has blown.	Replace the vehicle's DC socket fuse. Please refer to your vehicle operating manual.
This device does not function (AC mode), only use the power adapter to convert DC voltage	No voltage is detected in the AC power outlet.	Try to use another socket.
	Internal failure of this product.	It can only be repaired by an authorized repair center.
Don't use the application (APP)	Bluetooth is not connected.	Connect to Bluetooth, see the chapter "Set up Bluetooth and connect to the app"
The display shows reminder messages or warning codes.	-	See the table below.

Remind Message

Fault	Description	Possible cause	Suggested remedy
The inner light flashes- !ALERT-Lid open>3 min	Open the door for more than 3 minutes	The door is not closed tightly, or you forget to close the door.	Close the cover
	Others		Inspection by authorized repair center
F2 reminder-low voltage	Due to the low DC voltage, the equipment has stopped working	Insufficient power supply voltage	Check the voltage drop from the power supply to the outlet of this product, and increase the voltage if necessary.
		Battery voltage is too low	Test the battery and charge as needed
		The battery protection function is set too high	Choose a lower battery protection gear
	Because the DC voltage is too high (greater than 31.5V), the device is protected against power failure.	DC power supply voltage parameters do not match	Ensure that the power supply voltage parameters match the equipment.
		Abnormal power supply	Check the DC power supply, repair or replace the power supply if necessary
	others		Authorized maintenance center inspection

Remind Message

Warning code	malfunction	Possible cause	Suggested remedy
F3	Fan over current	Internal fault	Turn off the device for at least 5 minutes, then restart it. If the problem persists, you need to authorize a repair center to inspect it.
F4	Compressor start failure	system is high than 5 bar	/
F5	Compressor speed is low	The ambient temperature is too high	Turn off the device for at least 30 minutes, or move to a colder location, and then restart.
F6	Controller over temperature	If the refrigeration system has been too heavily loaded, or if the ambient temperature is higher than 55°C, the controller will run too hot	/
		Blocked vents or insufficient clearance around	Clear the vents and leave enough clearance with the surroundings
		Internal fault	Authorized repair center inspection
F1	NTC open	Internal fault	Need to be inspected by an authorized repair center
F1	NTC short circuit	/	/
F1	Switch error	/	Turn off the device for at least 1 minute, and then restart it. If the problem persists, you need to authorize a repair center to inspect it.
F1	Communication error	/	

8 Guarantee

The statutory warranty period applies. If the product is defective, please contact the manufacturer's branch in your country (see the back of the instruction manual for the addresses) or your retailer.

For repair and warranty processing, please include the following documents when you send in the device:

- A copy of the receipt with purchasing date
- A reason for the claim or description of the fault

9 Disposal

➤ Place the packaging material in the appropriate recycling waste bins wherever possible.



If you wish to finally dispose of the product, ask your local recycling centre or specialist dealer for details about how to do this in accordance with the applicable disposal regulations.



WARNING ! Risk of Children's playing

Before disposing of the old product:

- Remove the cover
- Put the basket inside the cooler to prevent children from climbing.

10 Technical data



WARNING!

If the (FC25L) ambient temperature is above 43 °C (109 °F), the temperature gauge cannot be down to the lowest value - 22°C.

Test/certificates:**CB,CE,RoHS,REACH,UKCA,SAA(COS),FCC,ICES etc.**

Item	Specifications
Model	FC25
Capacity	25L (24.7L)
Weight	10.9kg
Rated working voltage (DC input)	DC12/24 V MAX 4.5A/2.5A
Rated operating current (DC12/24V)	3.0A/1.8A
Working Ambient Temperature	+10°C- + 43°C
Temperature difference	54°C. Setting -22°C at ambient 32°C
Temperature setting range	+10°C ~ -22°C (+50°F ~ -8°F)
USB output	5V/2A
DC12V Cut on/Cut off Voltage	L-on/off(11.4±0.3/10.1±0.3)
	M-on/off(12.2±0.3/11.4±0.3)
	H-on/off(12.6±0.3/11.8±0.3)

Item	Specifications
DC24V Cut on/Cut off Voltage	L-on/off(23.0±0.3/21.5±0.3)
	M-on/off(25.3±0.3/24.1±0.3)
	H-on/off(26.2±0.3/24.6±0.3)
Bluetooth Response Time	Less than 5 seconds
Bluetooth Response Distance	Within 15 meters

The refrigerant of this product is R134a

Restriction of Hazardous Substances Directive (RoHS)

In order to meet the laws, regulations and other requirements related to the restriction of hazardous substances in electrical and electronic products of the People's Republic of China.

Our company classifies hazardous substances in this product according to parts, and declares as follows:

Box The name and content of hazardous substances in the product						
Parts	Harmful Substance					
	(Pb)	(Hg)	(Cd)	(Cr(VI))	(PBB)	(PBDE)
Box and its components	○	○	○	○	○	○
Door body and its components	○	○	○	○	○	○
Insulation Materials	○	○	○	○	○	○
Compressor	○	○	○	○	○	○
Compressor controller	X	○	○	○	○	○
Refrigeration components	○	○	○	○	○	○
Refrigerant	○	○	○	○	○	○
Electrical components	○	○	○	○	○	○
Power cord and connection line	○	○	○	○	○	○
Packaging and printing materials	○	○	○	○	○	○

This table is compiled in accordance with the regulations of SJ/T11364.

O: Indicates that the content of the hazardous substance in all homogeneous materials of the part is below the limit requirement specified in GB/T26572.

X: Indicates that the content of the hazardous substance in at least one of the homogeneous materials of the part exceeds the limit requirement of GB/T26572.

*All parts and their homogeneous materials that contain hazardous substances in the detailed list cannot be replaced by hazardous substances due to the limitation of the industry's technological development level. They comply with the strict requirements of the EU RoHS for the restriction of hazardous substances.

Please feel free to use them.

Reminder: In order to protect the environment, after this product or its components are scrapped, as a consumer have the responsibility to separate it from domestic waste and send it to a qualified recycling site, which will be classified and disassembled in accordance with relevant national regulations of recycling, etc.

For detailed information about the recycling of this product, please consult your local government, waste disposal agency, etc.



Electronic and electrical products sold within the territory of the People's Republic of China must be marked with this mark, and the number in the mark represents the environmental protection use period of the product under normal use.